

# WAGNER

Translation of the original  
Operating manual

**Basic 8000**

**Spray wall**

Version 12 / 2010



CE

P\_00475



## Contents

<b>1</b>	<b>ABOUT THESE INSTRUCTIONS</b>	<b>5</b>
1.1	Languages	5
1.2	Warnings, notes and symbols in these instructions	5
<b>2</b>	<b>GENERAL SAFETY INSTRUCTIONS</b>	<b>6</b>
2.1	Safety instructions for the operator	6
2.1.1	Electrical plant and units	6
2.1.2	Personnel qualifications	6
2.1.3	A safe work environment	6
2.2	Safety instructions for staff	7
2.2.1	Safe handling of WAGNER powder spray units	7
2.2.2	Grounding the unit	7
2.2.3	Material hoses	7
2.2.4	Cleaning	8
2.2.5	Handling powder paints	8
2.3	Using in accordance with the instructions	8
2.4	Use in an explosion hazard area	8
2.4.1	Using in accordance with the instructions	8
2.5	Safety features	9
<b>3</b>	<b>WARRANTY AND CONFORMITY DECLARATIONS</b>	<b>10</b>
3.1	Important notes on product liability	10
3.2	Warranty claim	10
3.3	CE-conformity	11
<b>4</b>	<b>GENERELL DESCRIPTION</b>	<b>12</b>
4.1	Delivery scope	12
4.2	Technical data	12
4.4	Design and functional description	13
<b>5</b>	<b>ASSEMBLING</b>	<b>14</b>
5.1	Requirements for the installation site	14
5.2	Setting up the system	15
5.2.1	The Basic 8000 spray wall as delivered	15
5.3	Assembly procedure	16
5.4	Grounding	17
<b>6</b>	<b>START UP</b>	<b>18</b>
6.1	Operation and display elements	19
6.2	Switching on the system	20
6.3	Switching off the system	20
6.4	Performing a color change	21
<b>7</b>	<b>CLEANING AND MAINTENANCE</b>	<b>22</b>
7.1	Setting the cleaning intervals	22
7.1.1	Basic functions	23
7.2	Check and maintenance of the compressed air container	24
7.2	Disposal	25
<b>8</b>	<b>ELIMINATION OF FAULTS</b>	<b>26</b>

## Contents

---

<b>9</b>	<b>SPARE PARTS</b>	<b>27</b>
9.1	How to order spare parts?	27
9.2	Spare parts list Basic 8000 spray wall	28
9.3	Spare parts list pressure tank	30
9.4	Spare parts list air diffuser	31
9.5	Connection set of the manual system	32
<b>10</b>	<b>ACCESSORIES</b>	<b>33</b>

# 1 ABOUT THESE INSTRUCTIONS

This operating manual contains information on the operation, repair and maintenance of the unit.

→ Always observe these instructions when operating the unit.

This equipment can be dangerous if it is not operated in accordance with this manual.

Compliance with these instructions constitutes an integral component of the warranty agreement.

## 1.1 LANGUAGES

The operating manual is available in the following languages:



Language:	Order No.	Language:	Order No.
German	3305594	English	3305595
French	3305596	Dutch	---
Italian	3305597	Spanish	3311304
Slovak	2306595		

## 1.2 WARNINGS, NOTES AND SYMBOLS IN THESE INSTRUCTIONS



Warning instructions in this manual point out particular dangers to users and equipment and state measures for avoiding the hazard.

These warning instructions fall into the following categories:



**Danger** - imminent danger. Non-observance will result in death, serious injury and serious material damage.

 <p>SIHI_0100_GB</p>	 <b>DANGER</b>
	<p><b>This line warns of the hazard!</b> Possible consequences of failing to observe the warning instructions. The signal word points out the hazard level.</p> <p>→ The measures for preventing the hazard and its consequences.</p>

**Warning** - possible danger. Non-observance can result in death, serious injury and serious material damage.

 <p>SIHI_0103_GB</p>	 <b>WARNING</b>
	<p><b>This line warns of the hazard!</b> Possible consequences of failing to observe the warning instructions. The signal word points out the hazard level.</p> <p>→ The measures for preventing the hazard and its consequences.</p>

**Caution** - a possibly hazardous situation. Non-observance can result in minor injury.

 <p>SIHI_0101_GB</p>	 <b>CAUTION</b>
	<p><b>This line warns of the hazard!</b> Possible consequences of failing to observe the warning instructions. The signal word points out the hazard level.</p> <p>→ The measures for preventing the hazard and its consequences.</p>

**Caution** - a possibly hazardous situation. Non-observance can cause material damage.

SIHI_0102_GB	<b>CAUTION</b>
<p><b>This line warns of the hazard!</b> Possible consequences of failing to observe the warning instructions. The signal word points out the hazard level.</p> <p>→ The measures for preventing the hazard and its consequences.</p>	

**Note** - provide information on particular characteristics and how to proceed.

## 2 GENERAL SAFETY INSTRUCTIONS

### 2.1 SAFETY INSTRUCTIONS FOR THE OPERATOR

- Keep these operating instructions to hand near the unit at all times.
- Always follow local regulations concerning occupational safety and accident prevention.



#### 2.1.1 ELECTRICAL PLANT AND UNITS

- To be provided in accordance with the local safety requirements with regard to the operating mode and ambient influences.
- May only be maintained by skilled electricians.
- Must be operated in accordance with the safety regulations and electrotechnical regulations.
- Must be repaired immediately in the event of problems.
- Must be put out of operation if they pose a hazard.
- Must be de-energized before work is commenced on active parts.
- Secure the control unit against being switched back on without authorisation. Inform staff about planned work.
- Observe electrical safety regulations.



#### 2.1.2 PERSONNEL QUALIFICATIONS

- Ensure that the unit is operated and repaired only by trained persons.

#### 2.1.3 A SAFE WORK ENVIRONMENT

- Ensure that the floor of the working area is anti-static (measurement in accordance with EN 1081).
- Ensure that all persons within the working area wear anti-static shoes.
- Ensure that gloves that are being worn, are made of conductive material.
- The powder release must be electronically interlocked with the powder spray system exhaust equipment.
- Excess coating material (overspray) must be collected up safely.
- Ensure that there are no ignition sources such as naked flame, glowing wires or hot surfaces in the vicinity. Do not smoke.
- Maintain sufficient quantities of suitable fire extinguishers and ensure that they are serviceable.
- The operating company must ensure that an average concentration of powder paint in the air does not exceed 50% of the lower explosion limit (LEL = max. permitted concentration of powder to air). If no reliable LEL value is available, the average concentration may not exceed 10g/m<sup>3</sup>.



## 2.2 SAFETY INSTRUCTIONS FOR STAFF

- Always follow the information in these instructions, particularly the general safety instructions and the warning instructions.
- Always follow local regulations concerning occupational safety and accident prevention.
- Under no circumstances should persons with pacemakers be in the area where the high-voltage field between the spray gun and the workpiece to be coated builds up!



### 2.2.1 SAFE HANDLING OF WAGNER POWDER SPRAY UNITS

- Never point the powder spray gun at people.
- Before all work on the unit, in the event of work interruptions and functional faults:
  - Switch off the energy/compressed air supply.
  - Secure the powder spray gun against actuation.
  - Relieve the pressure from the powder spray gun and unit.
  - By functional faults: Identify and correct the problem, proceed as described in chap. "Trouble shooting".



### 2.2.2 GROUNDING THE UNIT

The electrostatic charge may, in certain cases, give rise to electrostatic charges on the device. These can involve with unloading transmitting or flame formation.

- Ensure that the device is grounded before each coating process.
- Earth the workpieces being painted.
- Ensure that all persons inside the working area are earthed, e.g. that they are wearing antistatic shoes.
- Grounding cables must be checked regularly to ensure that they are serviceable (see EN 60204).



### 2.2.3 MATERIAL HOSES

- Only use original Wagner powder hose.



## 2.2.4 CLEANING

- De-energize the unit electrically.
- Disconnect the pneumatic supply line.
- Relieve the pressure from the unit.
- Secure the control unit against being switched back on without authorisation.
- Only mobile industrial vacuum cleaners of design 1 (see EN 60335-2) may be used for getting rid of dust build-ups.

## 2.2.5 HANDLING POWDER PAINTS

- Take note of the processing regulations laid down by the manufacturer of the powder paint being used, when preparing or processing the powder.
- Take note of the manufacturer's advice and the relevant environmental protection regulations when disposing of powder paints.
- Implement the prescribed safety measures, in particular the wearing of safety glasses and safety clothing as well as the use of protective hand cream.
- Use dust masks or breathing apparatus.
- To ensure sufficient protection of health and the environment, only operate the device in a powder booth or at a spray wall with activated ventilation (exhaust air).



## 2.3 USING IN ACCORDANCE WITH THE INSTRUCTIONS

WAGNER accepts no liability for any damage arising from incorrect use.

- Use the unit only to work with the materials recommended by WAGNER.
- Operate the unit only as an entire unit.
- Do not deactivate safety equipment.
- Use only WAGNER original spare parts and accessories.



## 2.4 USE IN AN EXPLOSION HAZARD AREA

### 2.4.1 USING IN ACCORDANCE WITH THE INSTRUCTIONS

The device is suitable for processing powder-type materials according to the explosion group categorization.



**2.5 SAFETY FEATURES**

Plates bearing information for the user have been attached to the work openings of the powder coating booth.  
 The plate size corresponds to the standard category Ø 100 mm; 3.94 inches.  
 The label plates, which must be attached, are shown below:



High-voltage!



Explosive atmosphere!



Forbidden for persons with a cardiac pacemaker!



Forbidden for unauthorized persons!



Smoking, fire and open light prohibited!

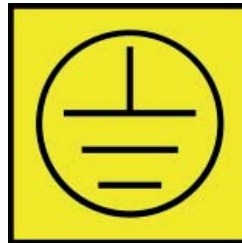

Grounding label:  
Serves as marker to attach a grounding disk while assembling the system.



Wear electrostatically conductive footwear!



Follow the instructions in the operating manual!



Wear respirator!

## **3 WARRANTY AND CONFORMITY DECLARATIONS**

### **3.1 IMPORTANT NOTES ON PRODUCT LIABILITY**

As a result of an EC regulation, effective as from January 1, 1990, the manufacturer shall only be liable for his product if all parts come from him or are approved by him, and if the devices are properly fitted, operated and maintained.

If other makes of accessory and spare parts are used, the manufacturer's liability could be fully or partially null and void.

The usage of original WAGNER accessories and spare parts guarantees that all safety regulations are observed.

### **3.2 WARRANTY CLAIM**

This equipment is covered by the following manufacturing warranty.

We will at our discretion repair or replace free of charge all parts which within 24 months in single-shift, 12 months in 2-shift or 6 months in 3-shift operation from date of receipt by the Purchaser are found to be wholly or substantially unusable due to causes prior to the sale, in particular faulty design, defective materials or poor workmanship.

The terms of the warranty are met at our discretion by the repair or replacement of the unit or parts thereof. The resulting costs, in particular shipping charges, road tolls, labour and material costs will be borne by us except where these costs are increased due to the subsequent shipment of the unit to a location other than the address of the purchaser.

This warranty does not cover damage caused by:

Unsuitable or improper use, faulty installation or commissioning by the purchaser or a third party, normal wear, negligent handling, defective maintenance, unsuitable coating products, substitute materials and the action of chemical, electrochemical or electrical agents, except when the damage is attributable to us.

This warranty does not cover damage caused by:

Unsuitable or improper use, faulty installation or commissioning by the purchaser or a third party, normal wear, negligent handling, defective maintenance, unsuitable coating products, substitute materials and the action of chemical, electrochemical or electrical agents, except when the damage is attributable to us.

Components not manufactured by Wagner are subject to the warranty terms of the original maker.

The replacement of a part does not extend the warranty period of the unit.

The unit should be inspected immediately upon receipt.

To avoid loss warranty, any apparent defect should be notified to us or the dealer in writing within 14 days from date of sale of the unit.

The right to commission warranty services to a third party is reserved.

Warranty claims are subject to proof of purchase by submitting an invoice or delivery note. If an inspection finds damage not covered by the present warranty, the repair will be carried out at the expense of the purchaser.

Note that this warranty does not in any way restrict legally entitled claims or those contractually agreed to in our general terms and conditions.

### **3.3 CE-CONFORMITY**

Herewith we declare that the supplied version of

- Basic 8000 spray wall, Article number 3301920, 3306211

Complies with the following provisions applying to it:

- 2006/42/EG (Machine guideline)
- 94/9 EG (ATEX)
- 2004/108/EG (EMV)

Applied standards, in particular:

- EN 12100-1: 2004-04
- EN 12100-2: 2004-04
- DIN EN ISO 14121: 2007-12
- DIN EN 60079-0: 2004-12
- DIN EN 60079-14: 2009-05
- DIN EN 60439-1: 2005-01
- DIN EN 60204-1: 2009-10
- DIN EN 50050: 2002
- DIN EN 50177: 2010-04
- DIN EN 954-1: 1997-03
- DIN EN 1127-1: 2008-02
- DIN EN 13463-1: 2009-07
- DIN EN 12981: 2010-06
- DIN EN ISO 13850: 2008-09

Marking:



#### **CE Certificate of Conformity**

The certificate is enclosed with this product. The certificate of conformity can be reordered from your WAGNER representative, quoting the product and serial number.

#### **Part number:**

Basic 8000 spray wall 3304086

## 4 GENERELL DESCRIPTION

### 4.1 DELIVERY SCOPE

Quantity	Order No.	Description
1		Basic 8000 spray wall
The standard equipment includes:		
1	3304086	CE-Declaration of Conformity
1	3305594	Operating manual German
1	also refer to chapter 1.1	Operating manual in the local language

### 4.2 TECHNICAL DATA

<b>Dimensions:</b>	
Filter surface	60 m <sup>2</sup> ; 646 sft
Number of filter cartridges	3
Suction performance of the booth	8000 m <sup>3</sup> /h; 10462 cy

<b>Electrical data:</b>	
Input air pressure	220-400 V
Input frequency	50 Hz
Nominal rating of drive motor	6 kW

<b>Pneumatic data:</b>	
Input air pressure	0.6-0.8 MPa; 6-8 bar; 97-116 psi
Air consumption	10-25 Nm/h <sup>3</sup> ; 353- 883 cf
Necessary air pressure quality	according to ISO 8573-1 class 2 Quality class 3.5.2
Sound pressure level	78 dB (A) without cleaning pulse

#### Article numbers:

**Variant**

Basic 8000 spray wall (left control cabinet):

Basic 8000 spray wall (right control cabinet):

**Article No.**

3301920

3306211

#### 4.4 DESIGN AND FUNCTIONAL DESCRIPTION

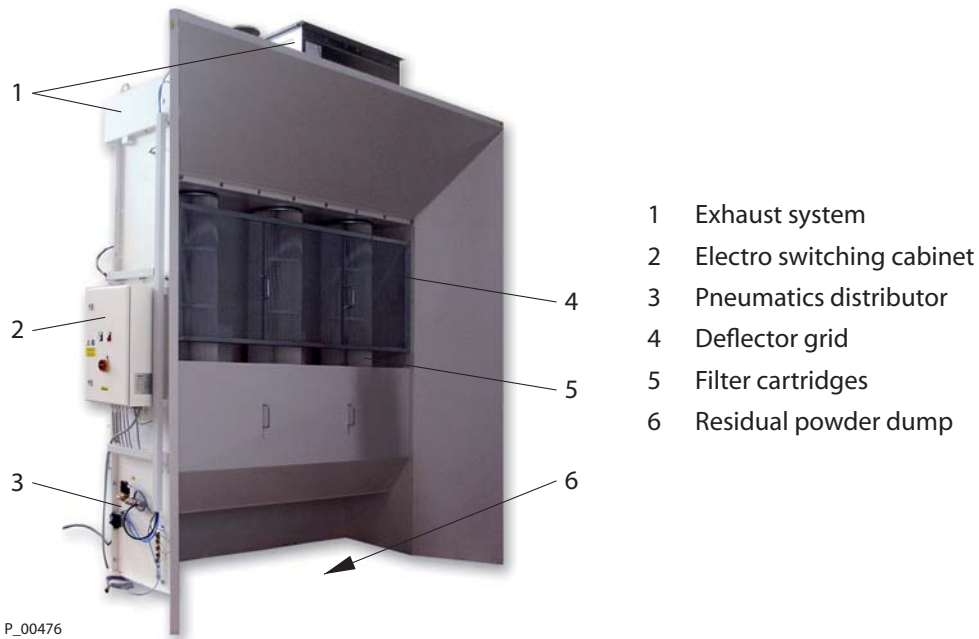

##### Characteristics:

- Suitable for coating bulky workpieces.
- Slanted guide sheets direct the airflow.
- Small footprint.
- Can be integrated within a conveyor system.



The Basic 8000 spray wall meets the requirements for electrostatic powder coating. The air that is suctioned off is filtered and can be reintegrated into the ambient air.

##### Functional principle:

The Basic 8000 spray wall is suitable for continuous operation. The air in the booth is suctioned off with the over-spray and guided through the deflector grate 4 to the filters 5. The filter elements (cartridges) are cleaned automatically; alternately each filter element is put out of operation and cleaned while the other elements remain in operation. The settings of the cleaning cycle depend on the type and quantity of the powder to be separated.

Waste powder gathers on the floor 6 and has to be regularly removed with an industrial vacuum cleaner.

## 5 ASSEMBLING

	 <b>WARNING</b>
	<p><b>Incorrect assembly/ installation!</b> Risk of injury and damage to the equipment.</p> <p>→ Installation may only be performed by trained and authorized persons. We recommend that installation work is carried out by WAGNER personnel.</p>

SIHI\_05007\_ENG

The Basic 8000 spray wall is delivered disassembled to the site of installation. Final assembly is performed on-site.

### 5.1 REQUIREMENTS FOR THE INSTALLATION SITE

Temperature range	0-40°C; 32-104°F
Max. air humidity	75%
Electrical connection	220-380 V/50 Hz
System ground (band or rod grounding)	according to VDE 0141 low impedance with NYAF > 16 mm <sup>2</sup>
Compressed air connection	0.6-0.8 MPa; 6-8 bar; 97-116 psi
Compressed air quality according to ISO 8573.1	Quality class 3.5.2

<h2>CAUTION</h2>
<p>For safe operations, the system requires a high compressed air quality! Any damage to the system that can be attributed to insufficient air quality must be rectified at the owner's expense. Wagner offers the appropriate maintenance unit. Ask Wagner service for advice.</p>

**5.2 SETTING UP THE SYSTEM**

	<b>WARNING</b>
	<p><b>Parts have high weights and centres of gravity!</b> Risk of injury and damage to equipment.</p> <ul style="list-style-type: none"> <li>→ Only use appropriate lifting tackle (crane, fork lift) for assembly.</li> <li>→ Secure the parts against tipping during transport.</li> <li>→ Cordon off assembly area to keep out unauthorised persons.</li> </ul>

SIHI\_05017\_ENG

**5.2.1 THE BASIC 8000 SPRAY WALL AS DELIVERED**

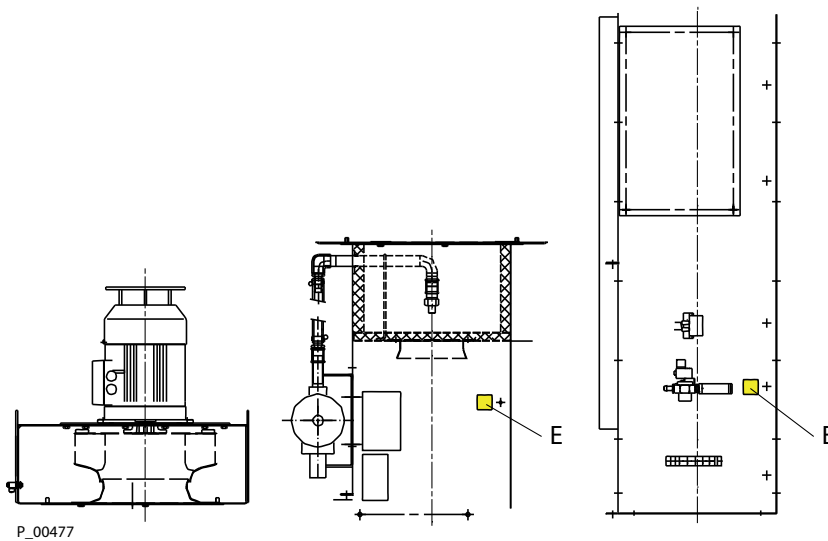

P\_00477



**E** Grounding label:  
marks the position to attach a grounding disk.  
Consider references in chapter 5.3 "Assembly procedure"!

**5.3 ASSEMBLY PROCEDURE**

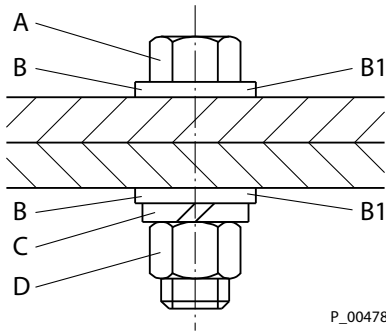

P\_00478

**Hint:**

On all connections on the booth, the M8 hexagonal screws must have washers B below the screw head A and washers B plus spring disks C below the hexagon nut D!

To assure a secure grounding between the elements of each module, the washer B located in at least two positions of every module must be replaced by a contact disk B1!

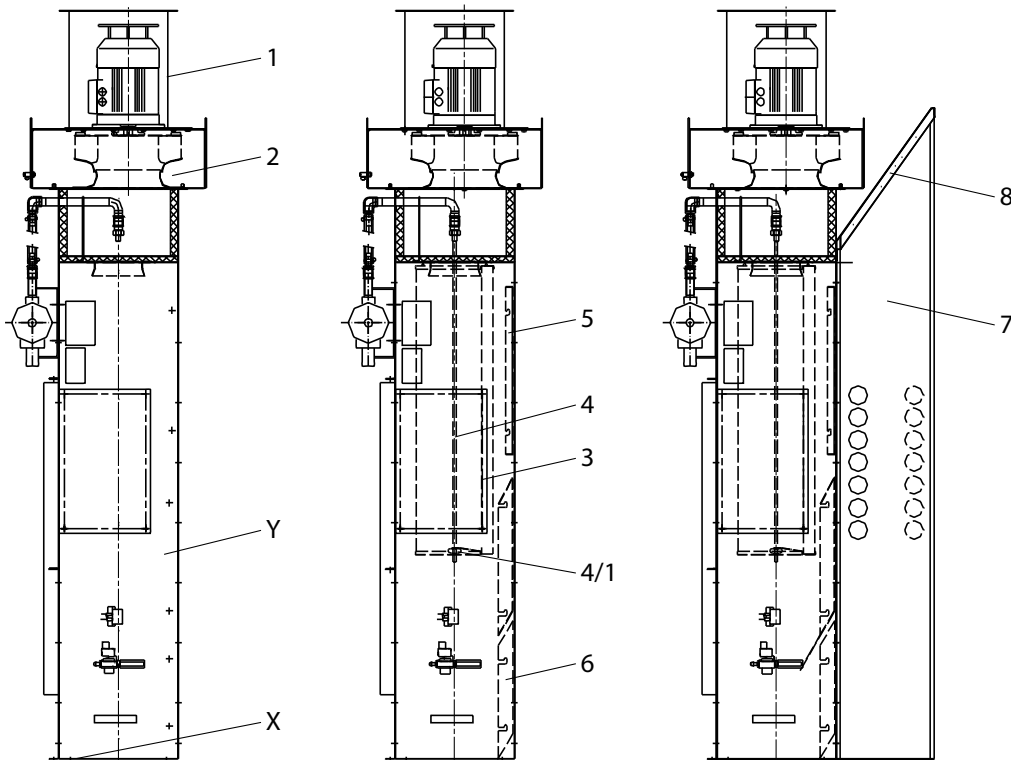

P\_00479



**Procedure:**

1. Install the lower section Y of the suction wall with a crane or forklift.
2. Secure the lower section Y with at least 2 floor dowel bolt X to the floor.
3. Mount the silencer 1 to the exhaust system 2 and the screw both to the lower section Y.
4. Insert the threaded bar 4 in the filter cartridge 3 and position both below the cartridge opening.
5. Screw the threaded bar 4 into the cleaning nozzle and tighten it by hand.
6. Hold up the filter cartridge 3 and screw the sealing washer and washer 4/1 with the star knob 4/1 onto the threaded bar 4.
7. Attach the deflector grate 5 and deflector 6.
8. Mount the side panels 7.
9. Mount the roof panels 8.
10. Align the spray wall and bolt it to the floor.

**5.4 GROUNDING**

The powder coating system must be perfectly grounded for safety reasons.

Wagner recommends the usage of a copper cable of at least 16 mm<sup>2</sup> with adequate mechanical strength.

It is important for system security and to achieve an optimum coating, that all system components such as workpieces, conveyors, control unit, color supply, control unit and booth or spray wall are perfectly grounded.

**The imperfect grounding of a workpiece will result in:**

- Dangerous electric charging of the workpiece.
- Very poor wrap-around.
- Uneven coating.
- Backspraying to the spray gun, i.e. contamination.

**The prerequisites for perfect grounding and coating are:**

- Good grounding of the workpiece to be coated.
- Grounding of the powder coating booth, transport and suspension equipment to be provided on site, in accordance with the corresponding Operating manuals or the definitions laid down by the manufacturer.
- Regular cleaning of hangers from powder residues.
- A grounding resistance for the workpiece of a maximum of 1 MΩ (mega ohm).
- Grounding cable connected to the controller module or control cabinet.

**If hooks or other hanger parts do not have all the paint removed, ignitable sparks can occur between workpiece and hangers. These sparks can cause strong radio frequency interferences.**

## 6 START UP

	<b>! WARNING</b>
	<p><b>Incorrect start-up!</b> Risk of injury and damage to equipment.</p> <p>→ Starting-up may only be performed by trained and authorized persons. We recommend that commissioning is carried out by WAGNER personnel.</p>

SIHI\_05011\_ENG

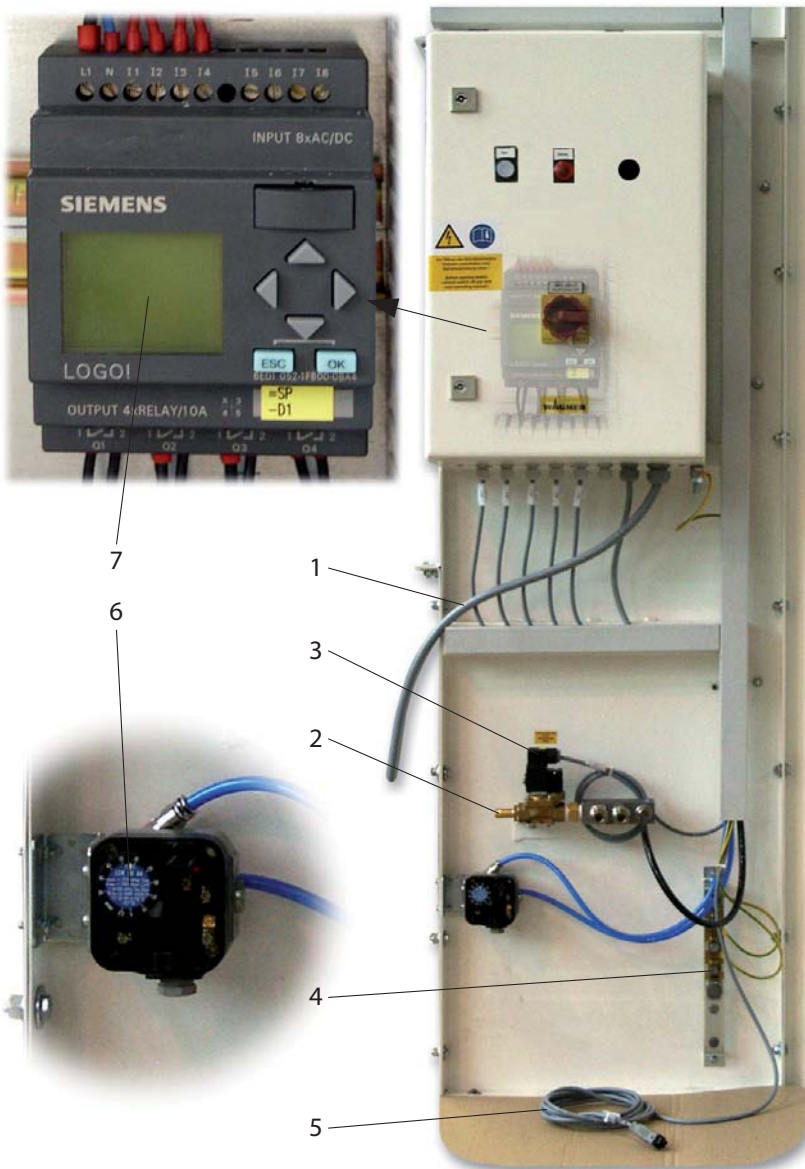

P\_00480

### Procedure of commissioning:

1. Connect the electrical supply 1 to the mains.
2. Connect the pneumatic supply 2 to the compressed air generator.
3. Connect the pneumatic hose of the manual system to nipple 3.
4. Connect the grounding cable of the manual system to the grounding bus 4 and to the grounding screw of the control unit.
5. Connect the system ground to the ground bus 4.
6. Connect the electrical cable 5 to the manual system.
7. Check the differential pressure monitor 6 and set it if required (normally, the factory settings of 2.0 kPa; 0.02 bar; 0.29 psi; need not be changed).
8. Check the cleaning system 7 and set if required (normally, the factory settings need not be changed).

## 6.1 OPERATION AND DISPLAY ELEMENTS

### Electro switching cabinet:

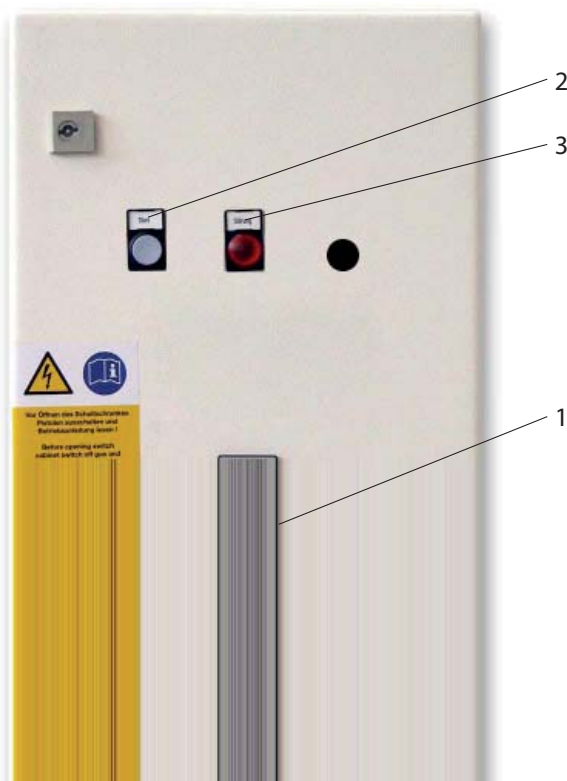

- 1 Main switch:  
Switches the system on and off.
- 2 Ventilator ON/OFF  
**Attention:**  
**Switch off the ventilator also via the main switch.**
- 3 Lights up red when the pressure difference of the filter cleaning operation has become excessive or a malfunction at the ventilator motor occurs \* (also refer to chapter 8).

\* When the set value of 2.0 kPa (kilo Pascal) is exceeded, the display lights up red (item 3 on the electro switching cabinet).

## 6.2 SWITCHING ON THE SYSTEM

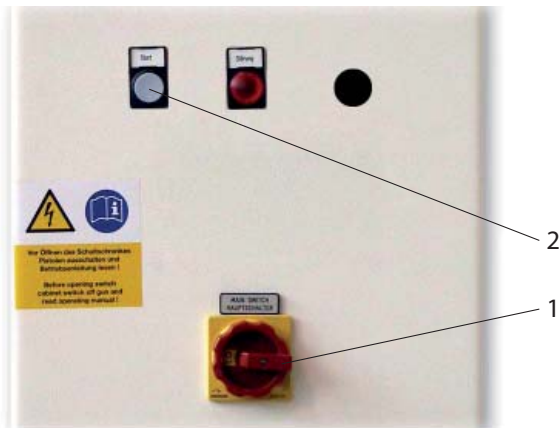

P\_00460

### Procedure:

1. Switch on the compressed air.
2. Switch on the main switch 1.
3. Switch on the ventilator 2.

The spray gun is released for coating in the booth, if all the necessary signals provided by the customer are present.

## CAUTION

If the cleaning operation is not activated, the nominal exhaust output is not reached.



## 6.3 SWITCHING OFF THE SYSTEM

During every interruption of operation, all powder conveying parts of the entire coating system should be cleaned of residual powder.

### Procedure:

1. Switch off the powder feed and the high voltage for the spray gun and secure them against being switched on unintentionally.
2. Clean the spray wall.
3. Switch off the main switch.

## 6.4 PERFORMING A COLOR CHANGE

	 <b>WARNING</b>
	<p><b>Dust development!</b> Risk of poisoning. Danger due to escaping dust, contamination of device and device components.</p> <p>→ During every color change, the suction system of the booth and the filter cleaning system must remain activated!</p>

SIHI\_05015\_ENG

In the case of a color change, powder residues must be thoroughly removed from all the powder-conveying parts throughout the complete coating system.

### Procedure:

1. Keep the suction system of the booth with the filter cleaning system activated.
2. Switch off the powder feed and the high-voltage for the spray gun and secure them against being switched on unintentionally.
3. Clean the parts of the powder feed system and the interior of the booth.
4. Scrape the color powder from the booth walls with a rubber scraper and remove it with a suitable industrial vacuum cleaner.
5. For recovery operations, replace the filter cartridges (1 set of cartridges per color). Store the cartridges in their packaging.
6. Coating can be continued with the new color powder.

## 7 CLEANING AND MAINTENANCE

	<b>DANGER</b>
	<p><b>Incorrect maintenance/repair!</b>                  Danger to life and equipment damage.</p> <ul style="list-style-type: none"> <li>→ Maintenance and repair work may only be carried out by trained personnel or by the Wagner Service Team.</li> <li>→ Switch the system off before starting work and secure it against being accidentally turned back on by anyone else (lock the main switch at the controller).</li> <li>→ Insure the proper grounding of all system components.</li> </ul>

SIHI\_05016\_ENG

Description	Check	Remark
Compressed air quality	at intervals	The compressed air connection at the control cabinet must be free of water, oil and dirt (also refer to chapter 4.2).

### 7.1 SETTING THE CLEANING INTERVALS

There is a LOGO-control unit in the control cabinet of the Basic 8000 which controls the cleaning intervals.

The basic functions are described on the following page.

You will find an exact description of this controller in a separate settings manual (article number: 3305994).

Normally, there is no need to make any settings at the LOGO controller and such work should only be done by qualified personnel.



**7.1.1 BASIC FUNCTIONS**



P\_00461

- 1 **ESC** to change to another menu or to discard the input
- 2 **OK** to select the parameters or to close the input
- 3 **Display** Menu display
- 4 **Cursor** to increase the value
- 5 **Cursor** to change to the other parameters
- 6 **Cursor** to change to the other parameters
- 7 **Cursor** to decrease the value

## 7.2 CHECK AND MAINTENANCE OF THE COMPRESSED AIR CONTAINER

	 <b>WARNING</b>
	<p><b>Defective parts!</b> Risk of injury and damage to the equipment.</p> <p>→ Remedy damage immediately and replace defective parts.</p>

SIHI\_05018\_ENG

### The rear of the spray wall:

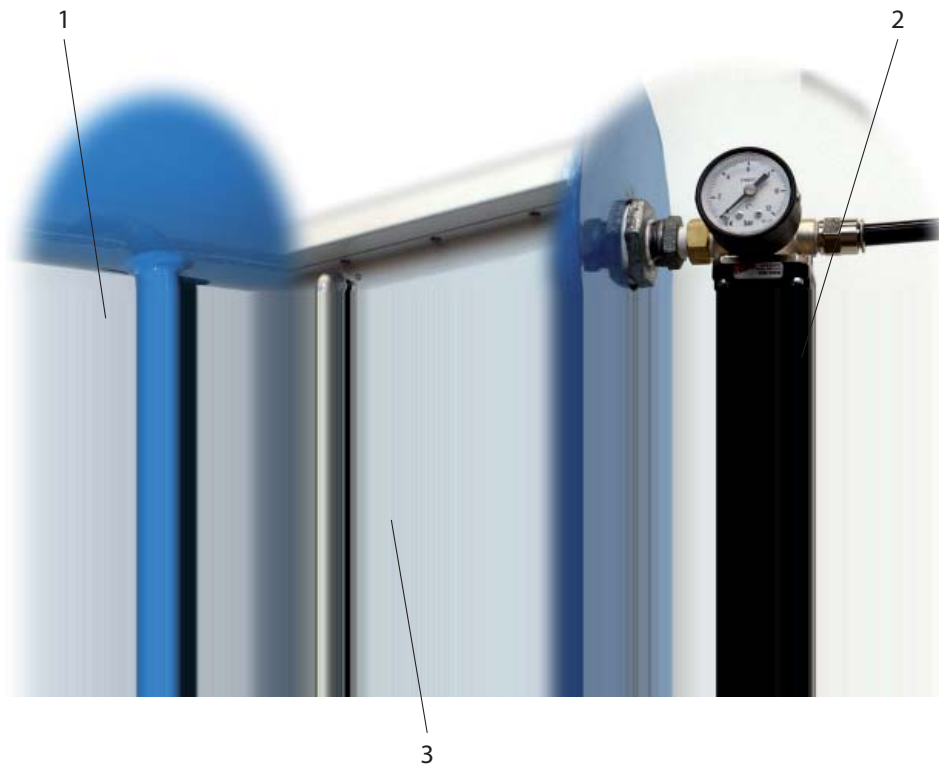

- 1 Blow-off valve  
Open to drain the compressed air container.
- 2 Pressure regulator with display.
- 3 Compressed air container for the cleaning system.



The compressed air container is normally maintenance free.

Check the following points regularly to prevent faults:

- Leakage in the inlet or supply lines.
- Leakage at the valve seat or saddle flange.
- Tank is firmly mount.
- If required, drain condensate (blow-off valve 1).

## 7.2 DISPOSAL

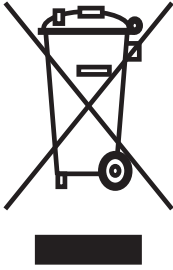
	<p style="text-align: center;"><b>HINT</b></p> <p><b>Do not dispose of waste electrical equipment with the household refuse!</b></p> <p>In accordance with European Directive 2002/96/EC on the disposal of waste electrical equipment and its implementation in national law, this product may not be disposed of with the household refuse, but must rather be recycled in an environmentally correct manner. Wagner or one of our dealers will take back your used Wagner waste electrical or electronic equipment and will dispose of it for you in an environmentally friendly way. Please contact one of our service points or one of our representatives or us directly to this purpose.</p>
--	---

SIHI\_05064\_ENG

## 8 ELIMINATION OF FAULTS

Malfunction	Cause	Remedy
Suction performance is too weak (safety stop triggers)	<ul style="list-style-type: none"> <li>● Fuses defective.</li> <li>● The filter cleaning system is not activated.</li> <li>● The solenoid valves in the filtering system are defective.</li> <li>● The cleaning filters are clogged.</li> </ul>	<ul style="list-style-type: none"> <li>● Replace the fuses.</li> <li>● Start and shorten the cleaning intervals if required (interval program in the control cabinet).</li> <li>● Replace the solenoid valves.</li> <li>● Clean or if required replace the filter cartridge.</li> </ul>
Dust is exhausted from the blower	<ul style="list-style-type: none"> <li>● The filter cartridges are loose or incorrectly installed.</li> <li>● The seal of the filter cartridge is defective.</li> <li>● The filter cartridges are damaged.</li> </ul>	<ul style="list-style-type: none"> <li>● Install the filter cartridges correctly.</li> <li>● Replace the foam rubber gasket.</li> <li>● Replace the filter cartridges.</li> </ul>
Excessive noise and/or vibrations from the housing	<ul style="list-style-type: none"> <li>● The ventilator bearings are defective.</li> <li>● Dust deposits on the ventilator blades.</li> </ul>	<ul style="list-style-type: none"> <li>● Replace the electric motor.</li> <li>● Clean the ventilator blades.</li> </ul>
No powder feed	<ul style="list-style-type: none"> <li>● The injector is clogged or worn.</li> <li>● The powder hose is dirty or bent.</li> <li>● The spray guns are clogged.</li> <li>● Insufficient feed or dosage air.</li> </ul>	<ul style="list-style-type: none"> <li>● Clean the injector and if required replace worn parts.</li> <li>● Clean the powder hose and check the hose for bends.</li> <li>● Clean the spray guns.</li> <li>● Check the air supply system.</li> </ul>

## 9 SPARE PARTS

### 9.1 HOW TO ORDER SPARE PARTS?

Always supply the following information to ensure delivery of the right spare part:

#### Order No., description and quantity

The quantity does not have to be identically to the numbers in the columns "Quantity" of the lists. This number merely indicates how many of the respective parts are used in each module.



The following information is also required to ensure smooth processing of your order:

- Address for the invoice
- Address for delivery
- Name of the person to be contacted in the event of any queries
- Type of delivery required (air freight or mail, sea route or overland route, etc.)

#### Marks in spare parts lists

Note to column "K" in the following spare parts lists.

- ◆ = Wearing parts  
**Hint:** No liability is assumed for wearing parts.
- = Not part of standard equipment, available, however, as additional extra.

	 <b>WARNING</b>
	<p><b>Incorrect maintenance/ repair!</b> Risk of injury and damage to equipment.</p> <ul style="list-style-type: none"> <li>→ Repairs and part replacement may only be carried out by specially trained staff or a WAGNER service center.</li> <li>→ Before all work on the unit and in the event of work interruptions:             <ul style="list-style-type: none"> <li>- Switch off the energy/compressed air supply.</li> <li>- Ensure that all system components are grounded.</li> <li>- Secure the control unit against being switched back on without authorisation.</li> </ul> </li> <li>→ Observe the operating and service instructions when carrying out all work.</li> </ul>

**9.2 SPARE PARTS LIST BASIC 8000 SPRAY WALL**

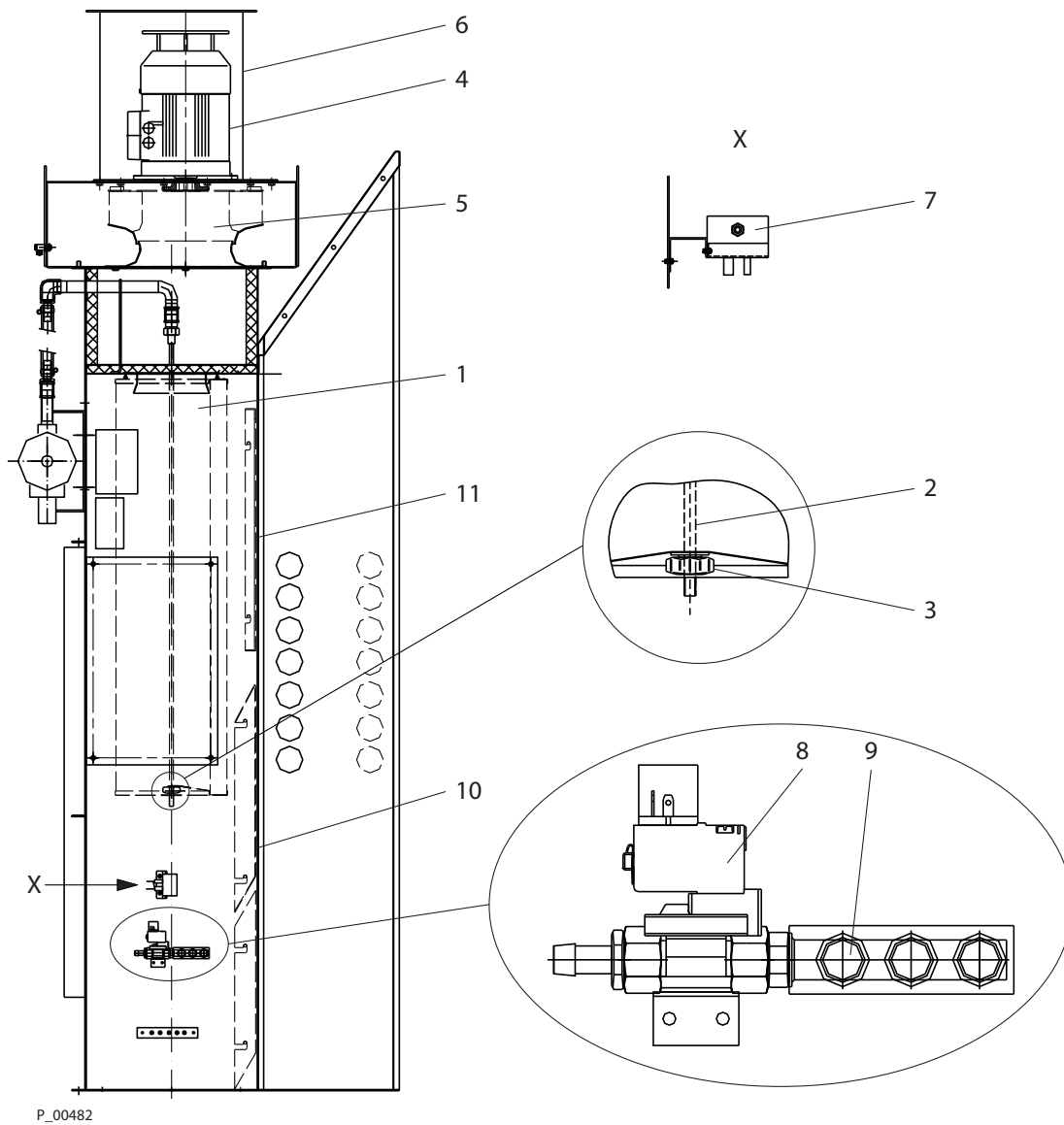

<b>Item</b>	<b>K</b>	<b>Quantity</b>	<b>Order No.</b>	<b>Description</b>
1		3	3159587	Filter cartridge with sealing washer
2		3	3143547	Threaded bar long
3		3	3143551	Star knob
4		1	3305671	Motor
5		1	3305672	Clockwise rotating impeller
6		1	3145385	Exhaust air muffler
7		1	3025456	Differential pressure monitor
8		1	3145435	Solenoid valve 2/2 way G1/2" 24 VDC
9		2	3305061	Coupling socket
10		1	3144945	Deflector
11		1	3144959	Deflector grid

**9.3 SPARE PARTS LIST PRESSURE TANK**

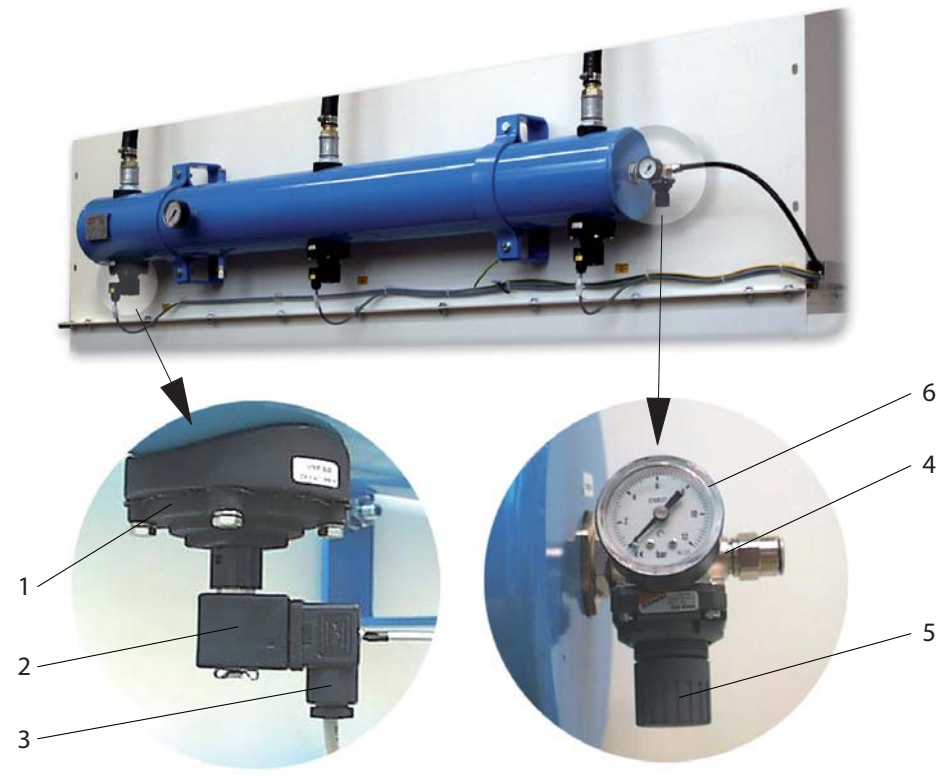

P\_00483

Item	K	Quantity	Order No.	Description
1		3	3306273	Diaphragm
2		3	3306439	Solenoid 230 VAC (up to 09/2007)*
2		3	3306274	Solenoid 24 VDC (from 09/2007)*
3		3	9955654	Valve connector MSSD-C 230 VAC (up to 09/2007)*
3		3	3304504	Valve connector design A 18 mm;0.71 inches 24 VDC (from 09/2007)*
4		1	3305056	Pneumatic control unit (complete)
5		1	3060190	Pressure regulator 1/4" 0.5 - 10 bar; 7.3 - 145.04 psi
6		1	114324	Pressure gauge

\* Before ordering spare parts, please check the voltage information on the integrated parts.

**9.4 SPARE PARTS LIST AIR DIFFUSER**

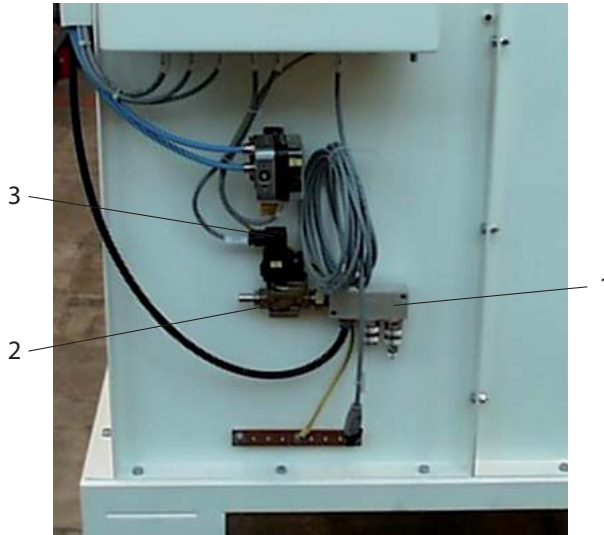

P\_00484

Item	K	Quantity	Order No.	Description
		1	3305064	Air diffuser (complete) 1/2" quadruple
1		1	3068948	Air diffuser 6704
2		3	3306439	Solenoid 230 VAC (up to 09/2007)*
2		3	3306274	Solenoid 24 VDC (from 09/2007)*
3		1	9955654	Plug

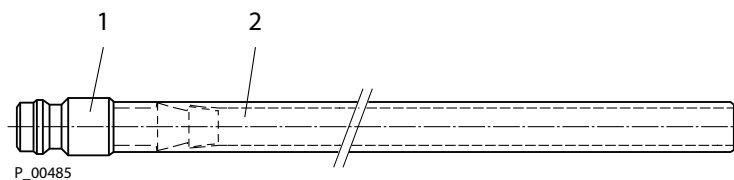
**9.5 CONNECTION SET OF THE MANUAL SYSTEM**

Item	K	Quantity	Order No.	Description
1			9992200	Plug-in nipple
2			3050061	Hose 8/6
			3051199	Cable binders (not shown, are included)



## 10 ACCESSORIES

---

<b>Order No.</b>	<b>Description</b>
3305529	Basic 8000 floor panel, large
3305528	Basic 8000 floor panel, small

<p><b>Germany</b> J. WAGNER GmbH Otto-Lilienthal-Str. 18 Postfach 1120 D- 88677 Markdorf Phone: +49/ 7544/ 505-0 Fax: +49/ 7544/ 505-200 E-mail: service.standard@wagner-group.com</p>	<p><b>Switzerland</b> J. WAGNER AG Industriestrasse 22 Postfach 663 CH- 9450 Altstätten Phone: +41/ 71/ 757 2211 Fax: +41/ 71/ 757 2222 E-mail: rep-ch@wagner-group.ch</p>
<p><b>Belgium</b> Estee Industries Leenbeekstraat 9 B- 9770 Kruishoutem Phone: +32/ 9/ 388 5410 Fax: +32/ 9/ 388 5440 E-mail: info@estee-industries.com</p>	<p><b>Denmark</b> WAGNER Industrial Solution Scandinavia Viborgvej 100, Skægkær DK-8600 SILKEBORG Phone: +45/ 70 200 245 Fax: +45/ 86 856 027 E-mail: info@wagner-industri.com</p>
<p><b>Great Britain</b> WAGNER Spraytech (UK) Ltd. The Couch House 2, Main Road GB- Middleton Cheney OX17 2ND Phone: +44/ 1295/ 714200 Fax: +44/ 1295/ 710100 E-mail: enquiry@wagnerspraytech.co.uk</p>	<p><b>France</b> Wagner - Division Solutions Industrielles Parc Gutenberg - Bâtiment F 8 voie la Cardon F- 91127 PALAISEAU Cedex Phone: +33/ 1/ 825/ 011111 Fax: +33/ 1/ 69 19 46 55 E-mail: division.solutionsindustrielles@wagner-france.fr</p>
<p><b>Netherlands</b> WAGNER Systemen Nederland Proostwetering 105 C NL- 3543 AC Utrecht Phone: +31/ 30/ 2410 688 Fax: +31/ 30/ 2410 765 E-mail: info@wagnersystemen.nl</p>	<p><b>Italy</b> WAGNER Itep S.p.A Via Santa Veccia, 109 I- 22049 Valmadrera - LC Phone: +39/ 0341/ 212211 Fax: +39/ 0341/ 210200 E-mail: wagnerit@tin.it</p>
<p><b>Japan</b> WAGNER HOSOKAWA Micron Ltd. No. 9, 1-Chome Shodai Tajka, Hirakata-Shi Osaka 673-1132 Phone: +81/ 728/ 566 751 Fax: +81/ 728/ 573 722 E-mail: sempara@kornet.net</p>	<p><b>Austria</b> J. WAGNER GmbH Otto-Lilienthal-Str. 18 Postfach 1120 D- 88677 Markdorf Phone: +49/ 7544/ 505-0 Fax: +49/ 7544/ 505-200 E-mail: service.standard@wagner-group.com</p>
<p><b>Sweden</b> WAGNER Industrial Solutions Scandinavia Skolgatan 61 SE - 568 31 SKILLINGARYD Phone: +46/ 370/ 798 30 Fax: +46/ 370/ 798 48 E-mail: info@wagner-industri.com</p>	<p><b>Spain</b> WAGNER Spraytech Iberica S.A. P.O. Boc., 132, Ctra. N- 340, KM 1245,4 E- 08750 Molins de Rei (Barcelona) Phone: +34/ 93/ 680 0028 Fax: +34/ 93/ 680 0555 E-mail: info@wagnerspain.com</p>
<p><b>China</b> WAGNER Spraytech Shanghai Co Ltd. 4 th Flr. No. 395 Jiangchanxi Road Shibei Industrial Zone Shanghai 200436 Phone: +86/ 2166 5221 858 Fax: +86/ 2166 5298 19 E-mail: wagnersh@public8.sta.net.cn</p>	<p><b>USA</b> WAGNER Systems Inc. 300 Airport Road, Unit 1 Elgin, IL 60123 Phone: +1/ 630/ 503-2400 Fax: +1/ 630/ 503-2377 E-mail: info@wagnersystemsinc.com</p>



# WAGNER



Order No. 3305595

**Germany**

J. WAGNER GmbH  
Otto-Lilienthal-Str. 18  
Postfach 1120  
D- 88677 **Markdorf**  
Phone +49/ (0)7544 / 5050  
Fax +49/ (0)7544 / 505200  
E-mail: service.standard@wagner-group.com

**Switzerland**

J. WAGNER AG  
Industriestrasse 22  
Postfach 663  
CH- 9450 **Altstätten**  
Phone +41/ (0)71 / 757 2211  
Fax +41/ (0)71 / 757 2222  
E-mail: rep-ch@wagner-group.ch

**[www.wagner-group.com](http://www.wagner-group.com)**